

Talk to a Turtle

Build a Computer Controlled Robot

What do personal computer experimenters do with their microcomputers when computer games lose their appeal and they tire of programming things like, "140 FOR X = 1 to 500: PRINT X: NEXT X"? The exciting idea of adding a computer controlled robot suggests building your own R2-D2 robot from *Star Wars*. It might not be wise to start with a project as sophisticated as duplicating R2-D2, but there *is* a way

you can begin a robot project on a smaller scale. It works, too!

The Terrapin Turtle is a fascinating robot project that most experimenters can fully assemble in four hours. It runs forward, backward, turns left or right, blinks light emitting diode eyes, and can talk in a two tone beep. Its shell is mounted on a spindle that engages one of four microswitches. These relay a signal back to the computer

James A Gupton Jr
7416-G Pebblestone Dr
Charlotte NC 28212

ABOUT THE AUTHOR:

Mr James Gupton Jr has a most unusual background including photography, electro-optics research and development (which resulted in five patents on computer video display tubes and phosphor screens), along with teaching electronics. The Union County Career Center is the only high school in North Carolina to provide an electronics program which covers subjects from direct current to microprocessors. This program is under the guidance of Mr Gupton.

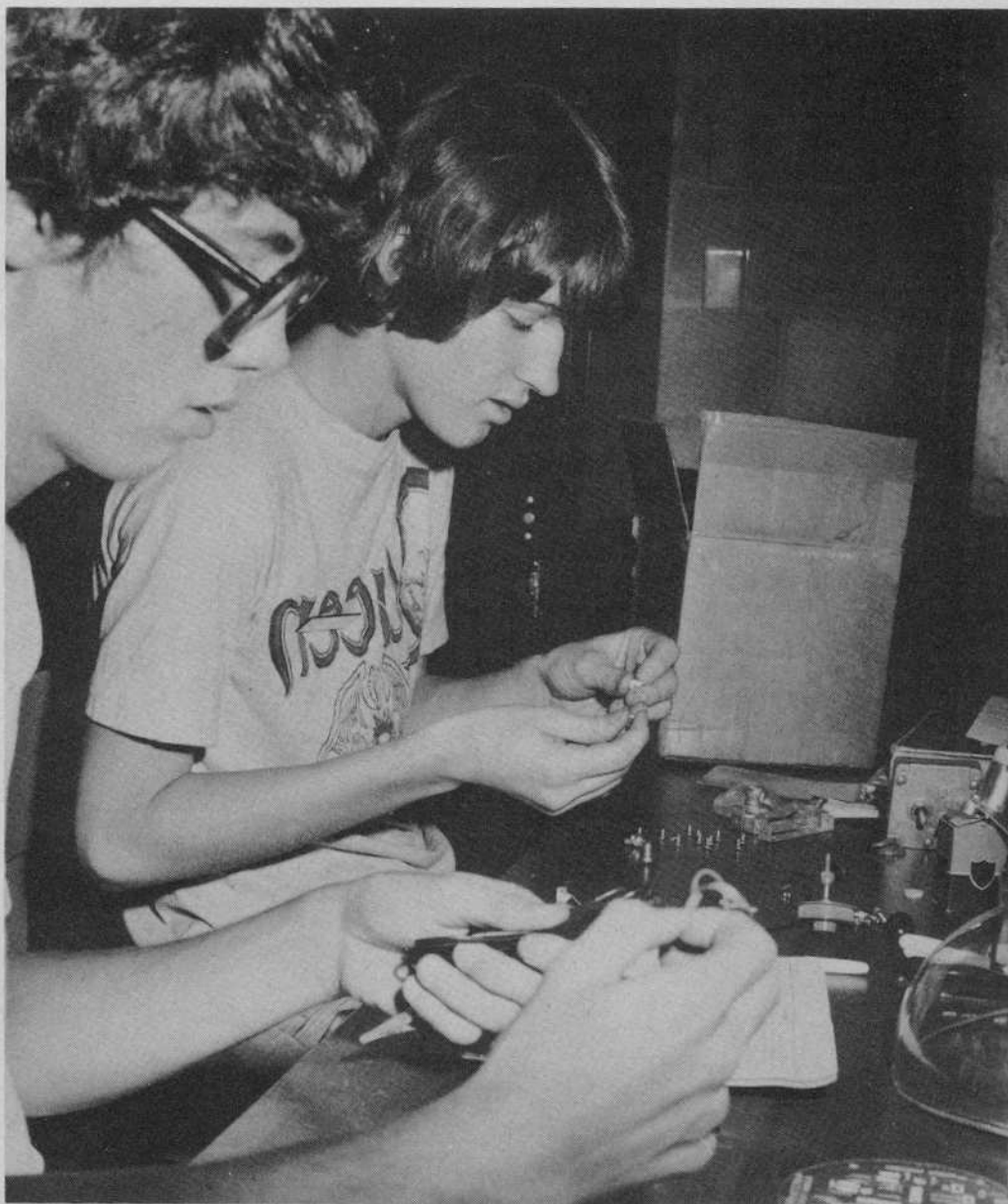

Photo 1: Jeffrey Dunn (foreground) and Richard Voss check off the Turtle components against the parts list.

over its 10 foot umbilical cord, indicating when the Turtle has run into something from either front, right, left, or rear side. If you direct the Turtle on an exploratory trip around the room, its journey can be recorded by your microcomputer. On completing its journey, the Turtle can actually draw a map of its path using an internal ball point pen.

The Terrapin Turtle illustrated in this article was assembled by high school students at the Union County Career Center in North Carolina. The total assembly time was four hours from start to initial test. This article is not intended for use as a construction project, but rather to introduce you to computer controlled robots.

Assembling the Terrapin Turtle

The cardinal rule for assembling any electronic kit is to begin by checking off each component on the parts list. Photo 1 shows Jeffrey Dunn and Richard Voss checking the components of the Turtle kit

Resistors

510 ohm ¼ W: R9, R10
 100 ohm ¼ W: R21, R30
 15 K ohm ¼ W: R5, R6, R7, R8, R29, R22
 50 K ohm ¼ W: R19, R20
 1 K ohm potentiometers: P1, P2, P3, P4
 1 K ohm ¼ W: R1, R2, R3, R4, R11, R12, R13, R14, R15, R16, R17, R18, R23, R24, R25, R26, R27, R28

Capacitors

C1 0.1 mF 35 V
 C2, C3 500 mF 35 V

Diodes

1N4000 D1, D2, D3, D4, D5, D6, D7, D8, D9
 3.9 V zener D10

Transistors

2N2222 Q1, Q2, Q3, Q4, Q5, Q6, Q7
 GE-D40C4 Q8, Q9, Q10, Q11, Q12, Q13, Q14, Q15, Q19

Table 1: The Turtle component part list. The complete Turtle kit, including all hardware, printed circuits, electronic components is available from Terrapin Inc for \$300.

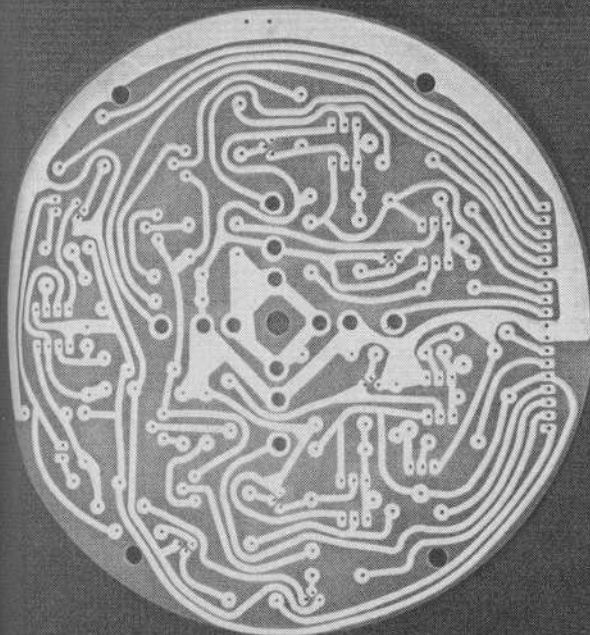

Photo 2: The foil side of the Turtle's printed circuit board.

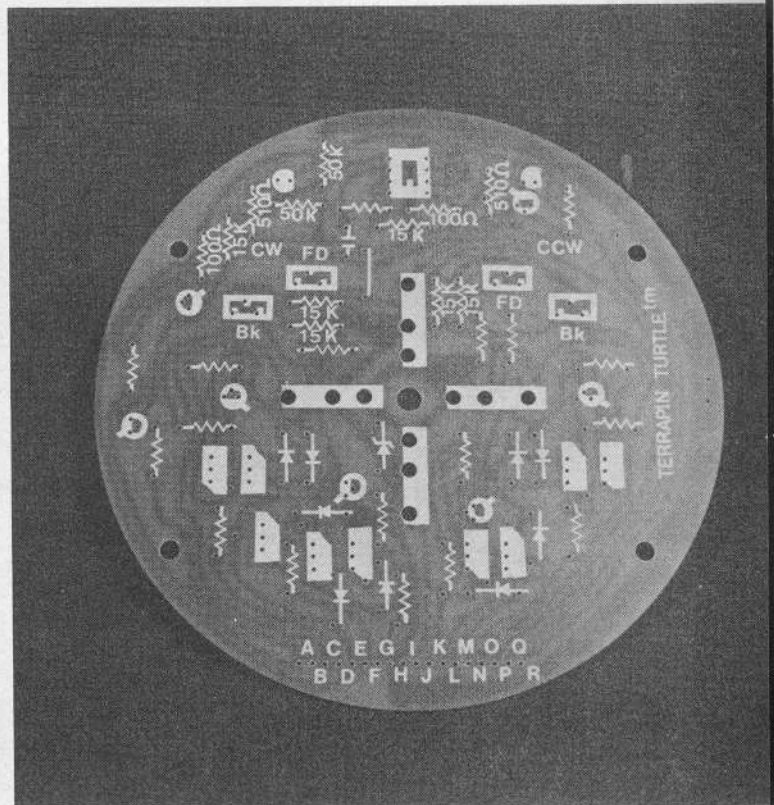

Photo 3: The component side of the circuit board.

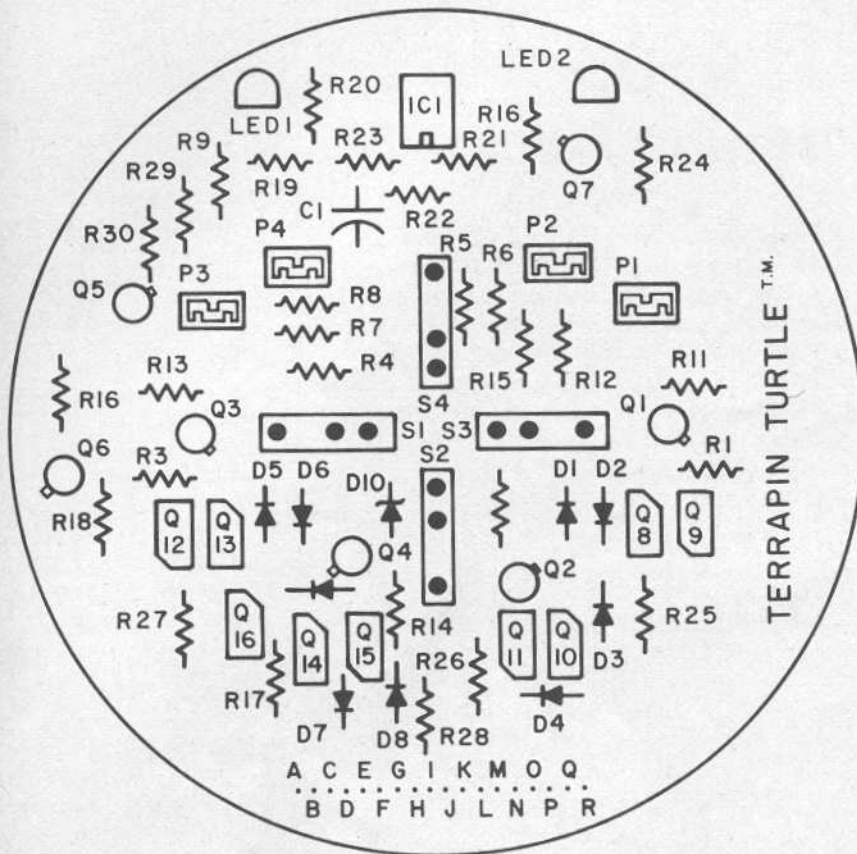

Figure 1: Supplemental diagram showing component identification numbers which relate to schematic locations.

against the parts list. Once assured that everything was included in the kit, the printed circuit board was examined for possible scratches. Photo 2 shows the etch side of the 5 inch diameter printed circuit board. Photo 3 shows the component side. It was quickly noted that not all resistor values were printed on the component side, and that there was no identifying resistor number to relate any resistor to the schematic. The instruction booklet stated that eighteen 1000 ohm resistors should be placed where the resistor symbols did not have a value indicated. Figure 1 is a supplemental instruction that identifies each component corresponding to the schematic diagram.

Richard Voss was in charge of assembling the printed circuit board for the Union County Career Center's Turtle. Photo 4 shows the soldering of the Darlington transistors that control both of the Turtle's drive motors. Notice the micro-tip, low wattage soldering iron and 0.020 inch (0.05 cm) diameter solder being used. All too frequently electronic kits are damaged during assembly by the use of high wattage soldering tools which damage the heat sensitive foil and apply too much solder. An excess of solder can short out both the closely spaced component pads and the circuit paths with solder bridges. Once the soldering has been

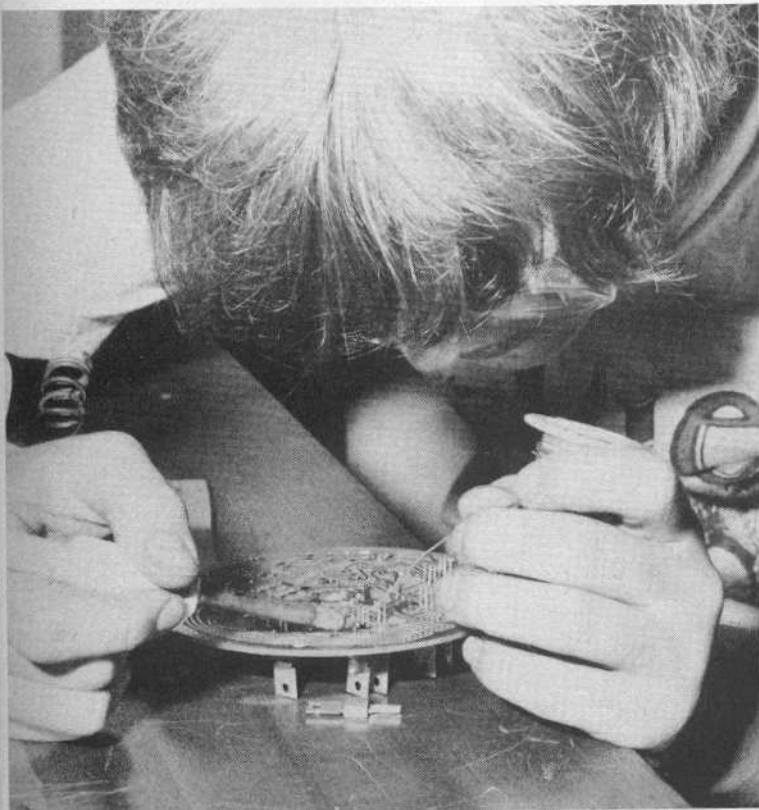

Photo 4: Soldering the installed components.

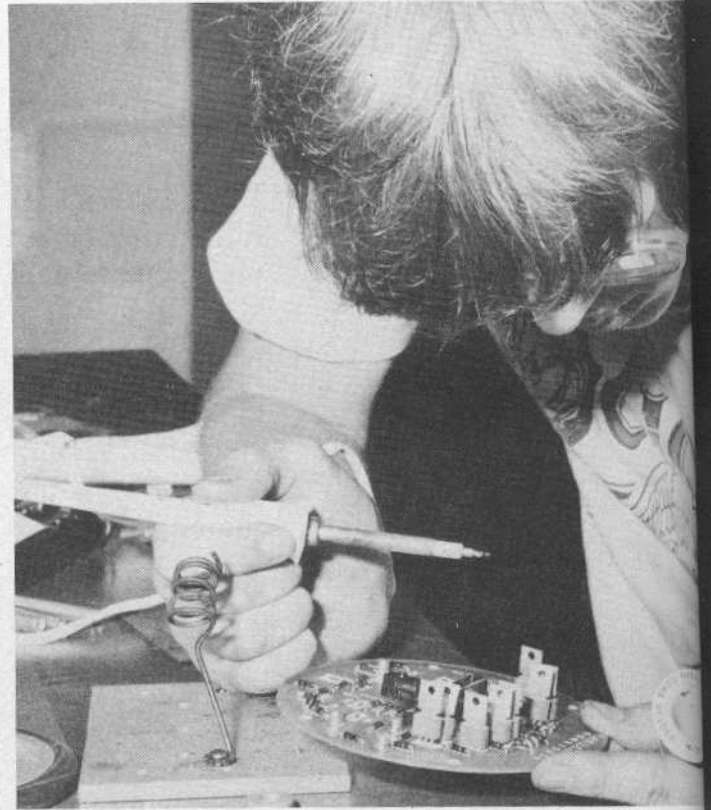

Photo 5: Inspecting the assembled components.

finished, it is wise to recheck the placement of the components, just to be doubly sure.

Care must be exercised to keep the tabs on the Darlington transistors from touching one another. A small piece of plastic tape on each tab will save the transistor should the tabs accidentally be brought together while under power. Photo 5 shows the final inspection of the assembly of components onto the printed circuit board. Photo 6 shows the completed circuit board.

Figure 2 provides the circuit schematic for the control of the Turtle's left and right motors and the internal ball point pen. The pen is lowered by a 12 V solenoid upon command from the computer. Figure 3

shows the schematic for shell touch sensors, lights, and sound control. The figure also shows the power attachment points for the operation of the Turtle's electronics and motors. A 12 V, 3 A power source is required for the best performance. The Turtle can operate, however, with a power source of 1 A capacity if the 3 A source is not available. The Turtle illustrated in this article was powered by a 4 A regulated power supply.

Photo 7 shows the final assembly of the printed circuit board onto the motor housing. The most difficult part of the entire assembly was forcing the rubber tires onto the wheels. It is almost impossible to do this

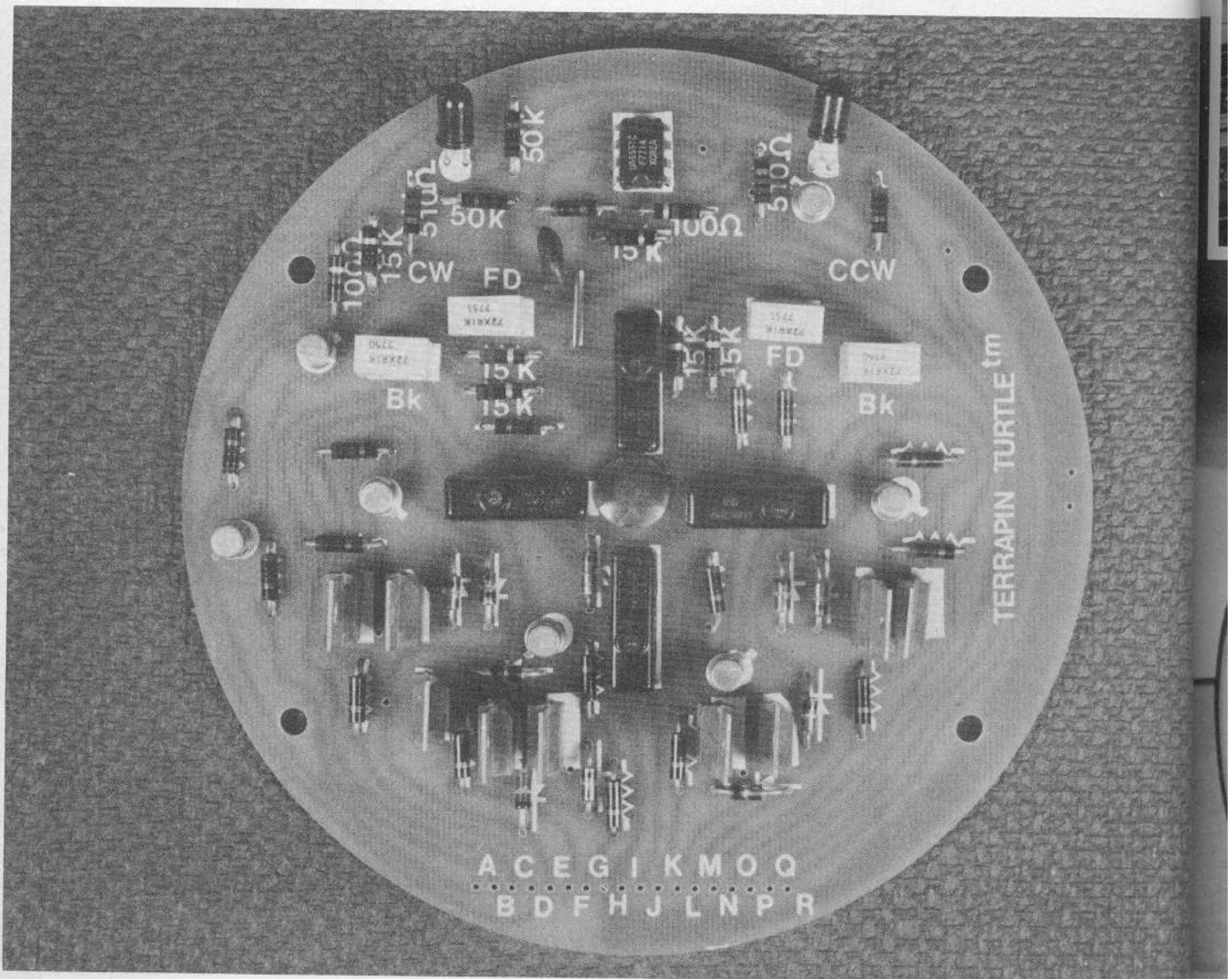

Photo 6: The completed board, showing the uncluttered layout.



Photo 7: The printed circuit board, shown attached to the Turtle's motor drive housing.

by yourself — a second set of hands will be needed to mount the rubber tire onto the wheel. Photo 8 shows the assembled Turtle minus its sensor shell and the two power supplies used for testing without the use of a microcomputer. The Turtle is controlled with a TTL (transistor-transistor logic) voltage of 0 V and +2 V. This may cause some problems for parallel interfaces that function between 0 V and +5 V. The higher voltages can damage the 2N2222 Darlington tran-

Text continued on page 84

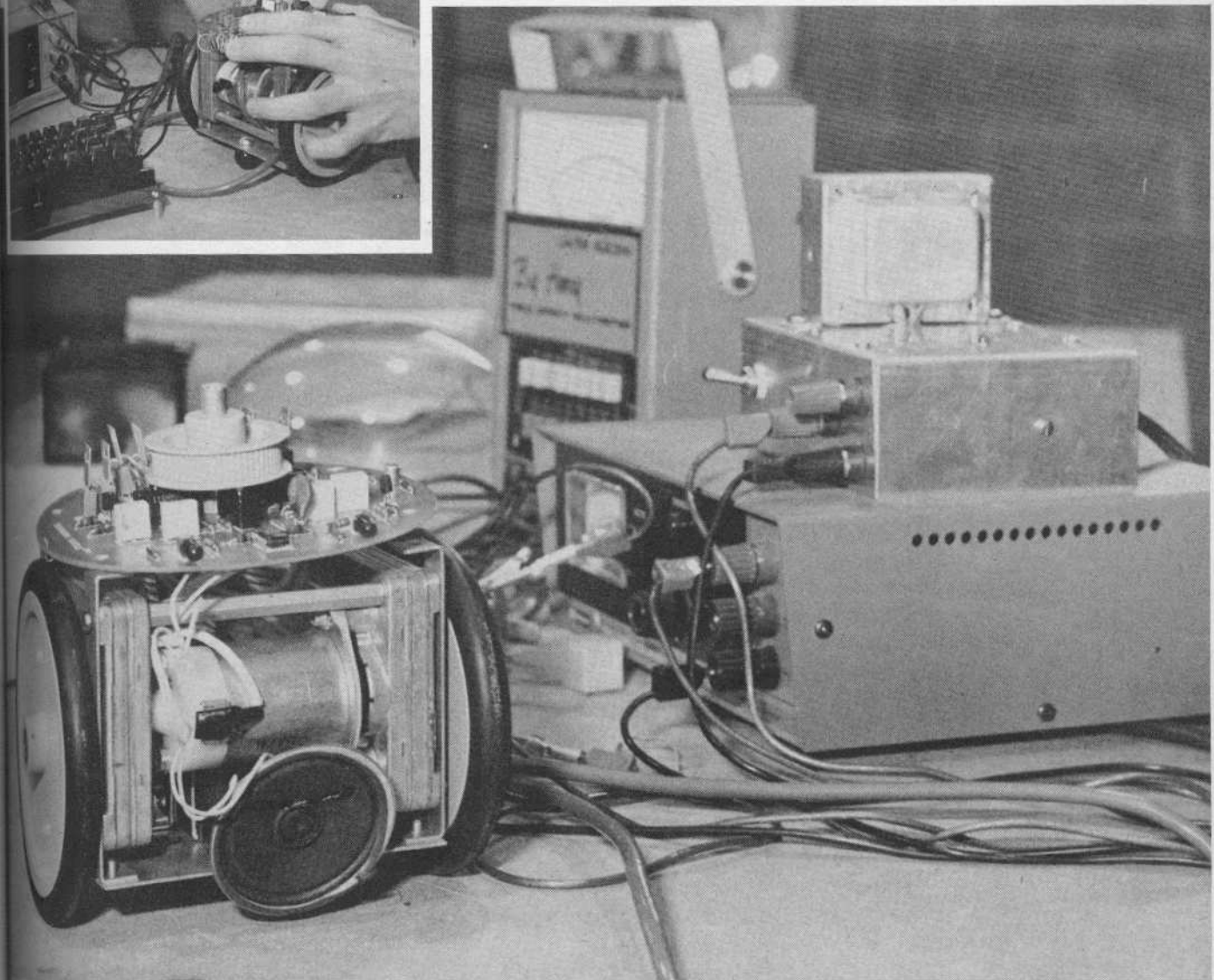

Photo 8: The completed Turtle, connected to a power supply for testing.

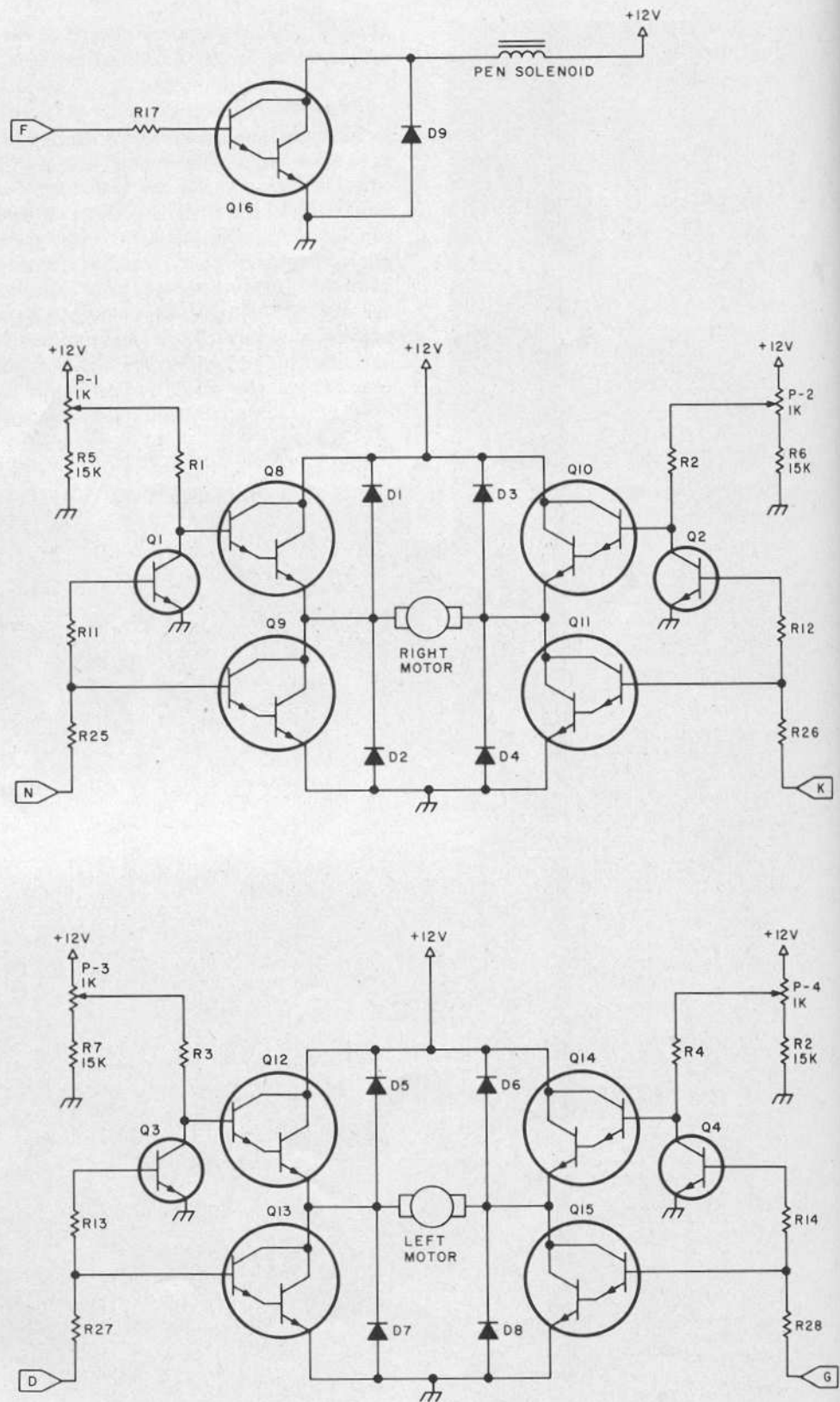

Figure 2: Schematic of the Turtle's motor control and pen control circuitry.

SHELL TOUCH CONTROL

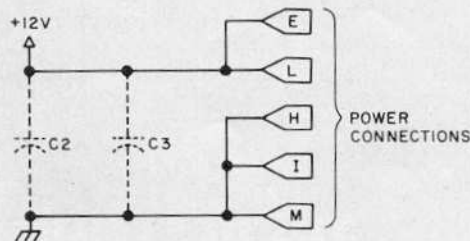
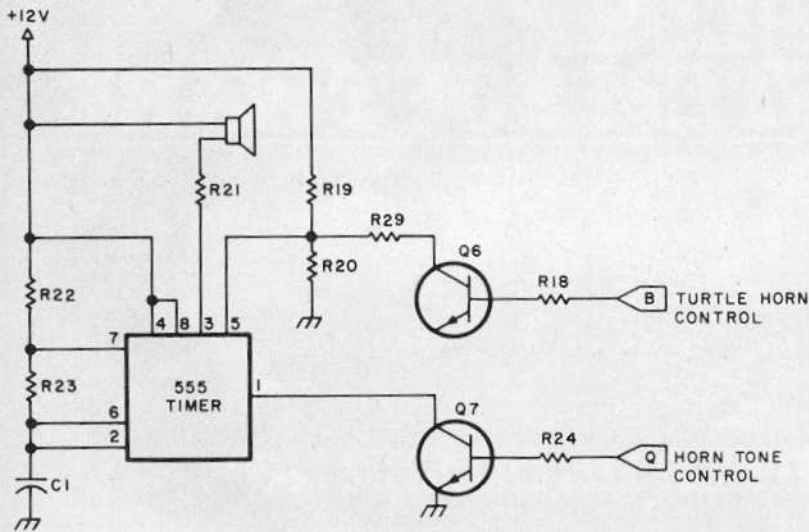
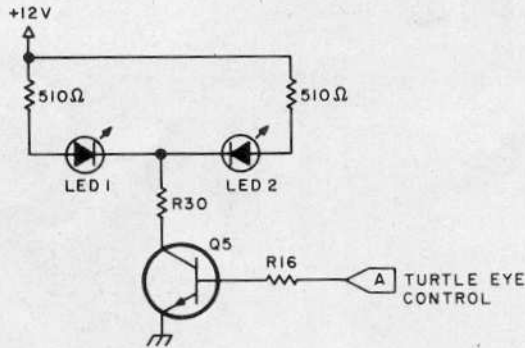
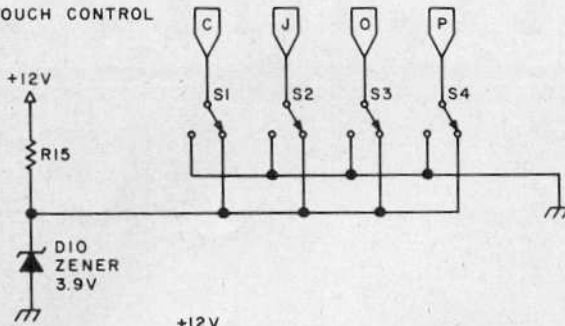

Figure 3: Schematic of the Turtle's touch sensor, lights, and horn control circuitry.

Anadex Domestic Representatives:

Barnhill Two, Inc.

Richardson, Texas
(214) 231-2573
Houston, Texas
(713) 688-9971
Austin, Texas
(512) 451-0217

Barnhill Three, Inc.

Denver, Colorado
(303) 750-1222
Scottsdale, Arizona
(602) 947-7841
Albuquerque, New Mexico
(505) 299-7658
Salt Lake City, Utah
(801) 484-4496

Basic Systems, Inc.

Inglewood, California
(213) 673-4300
San Diego, California
(714) 279-9641

Carter, McCormic & Perice, Inc.

Farmington, Michigan
(313) 477-7700
Dayton, Ohio
(513) 222-7700
Cleveland, Ohio
(216) 779-5100
Monroeville, Pennsylvania
(412) 372-4415

Currie, Peak & Frazier, Inc.

Orlando, Florida
(305) 855-0843
Huntsville, Alabama
(205) 536-5650
Greensboro, North Carolina
(919) 273-3040

Rush S. Drake Associates, Inc.

Seattle, Washington
(206) 763-2755
Portland, Oregon
(503) 224-3145

Electronic Marketing Associates

Rockville, Maryland
(301) 881-5300
King of Prussia, Pennsylvania
(215) 265-1600

Pat Jenks Associates

Hamden, Connecticut
(203) 281-0810
Wakefield, Massachusetts
(617) 246-1590

Ossman Instruments, Inc.

East Syracuse, New York
(315) 437-6666
Rochester, New York
(716) 473-5720
Vestal, New York
(607) 785-9947

Pivan Engineering Company

Chicago, Illinois
(312) 539-4838
Saint Louis, Missouri
(314) 567-3636
Shawnee Mission, Kansas
(913) 722-1030
Indianapolis, Indiana
(317) 253-1681
Minneapolis, Minnesota
(612) 835-3060
Brookfield, Wisconsin
(414) 786-1940
Cedar Rapids, Iowa
(319) 377-9434

Jay Stone & Associates

Los Altos, California
(415) 948-4563

Technical Marketing Associates

Fort Lee, New Jersey
(201) 224-6911

Circle 7 on inquiry card.

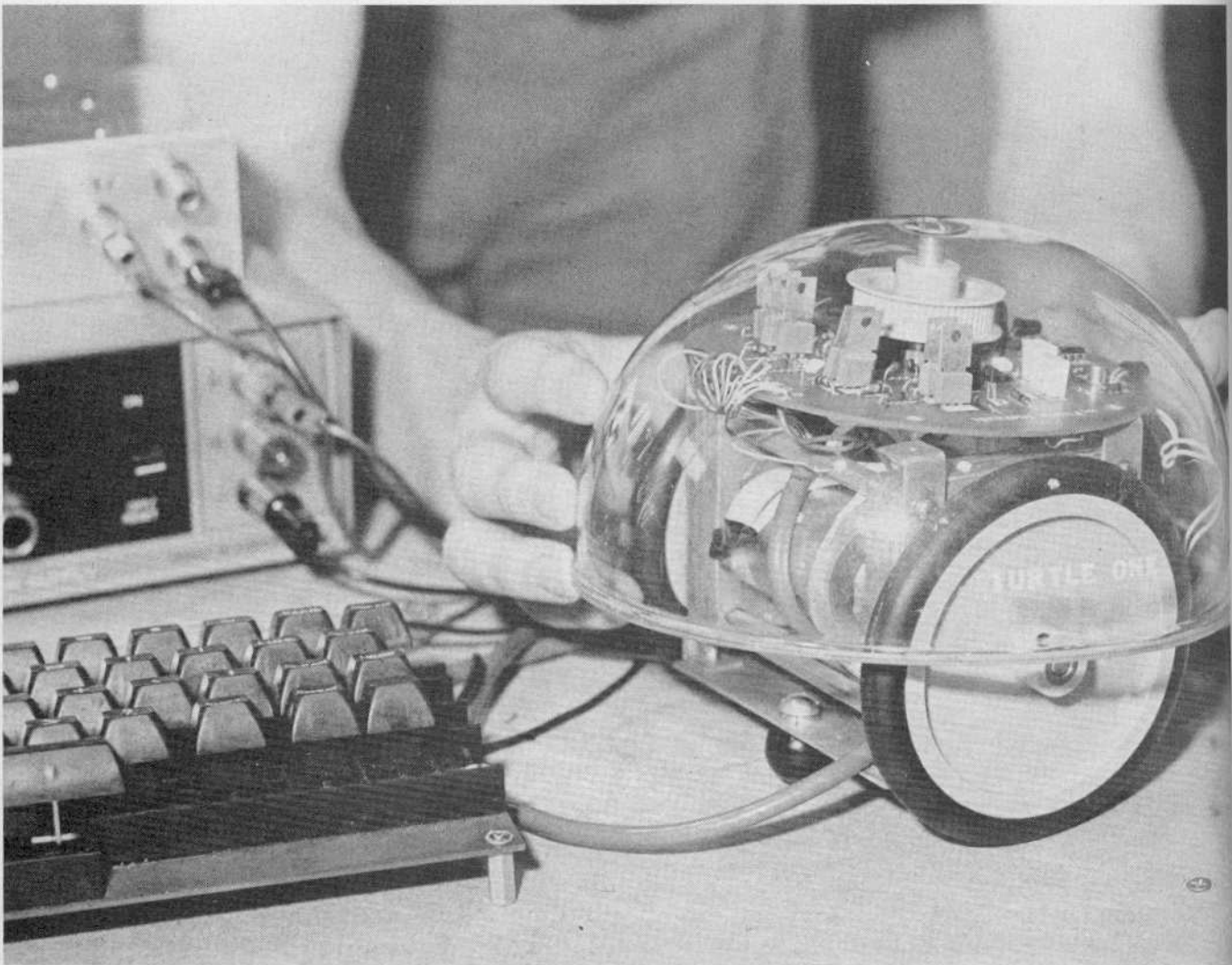

Photo 9: The Turtle with shell attached as a final assembly step.

Text continued from page 79:

sistor driver. Photo 9 shows the attachment of the plastic Turtle shell.

Does the Turtle work? Yes it does, even with a makeshift computer keyboard temporarily substituting for the parallel interface of our computer. The students studied the keyboard's ASCII code and developed a list of keys necessary to command the Turtle's movements, lights, and horn. The Turtle will go under full computer control as soon as an expansion interface can be acquired for our TRS-80 microcomputer.

Those wishing to investigate the Turtle kit, its capabilities, and its cost may obtain

full details by writing to:

Terrapin Inc
33 Edinborough St Sixth Floor
Boston MA 02111
Attention: David L McClees, President

In addition, the following address is furnished for those wishing additional information on the application of robots:

United States Robotics Society
Box 26484
Albuquerque NM 87125
Attention: Glenn R Norris, President